

SUBARU
360

Unique styling / Dependable engine / Highly economical

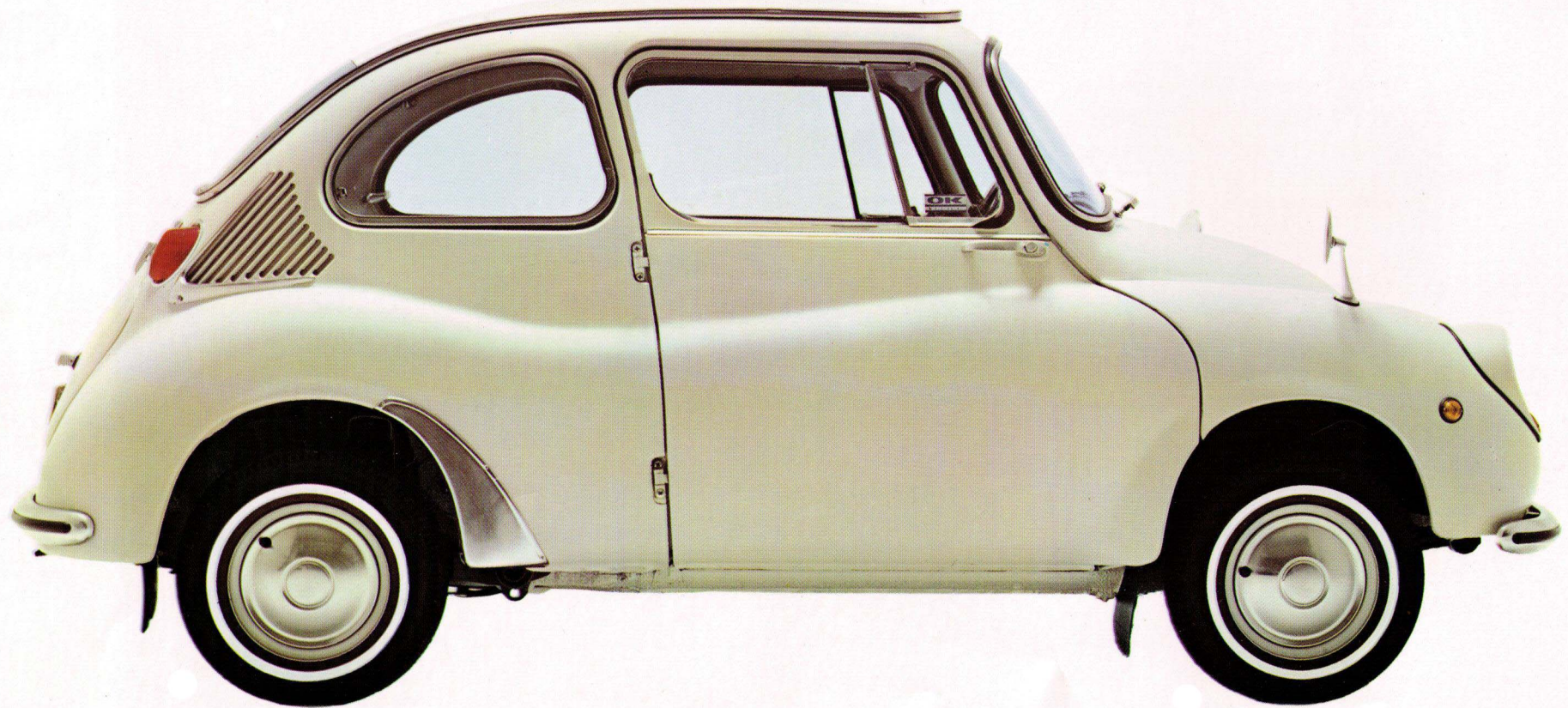

Body styling remains unchanged since 1958

The modest and unique body styling of the Subaru 360 has remained unchanged from the beginning... ever since 1958 when the first Subaru 360 appeared on the market. It's because we couldn't find a good reason for changing it. But that doesn't mean we haven't changed anything inside the body. We're all for significant engineering advances. That's why we've made numerous refinements—over 1,400

in fact—throughout the years. These improvements don't readily meet the eye, but they soon become evident out on the road.

You can tell it's a Subaru 360 the minute you see it because of its outstanding styling. But you'll have to drive it to believe its extraordinary performance. It boasts the ultimate in small-car performance because the engineers and technicians at Fuji Heavy Industries, Ltd.,

manufacturers of the Subaru 360, have produced a car that is more durable, more spacious and of higher performance than any other vehicle in its class.

There's nothing unnecessary on the Subaru 360. Only the ultimate in functional design went into it. That's why it's so functionally beautiful. And that's why our customers never grow tired of this superbly designed Subaru 360.

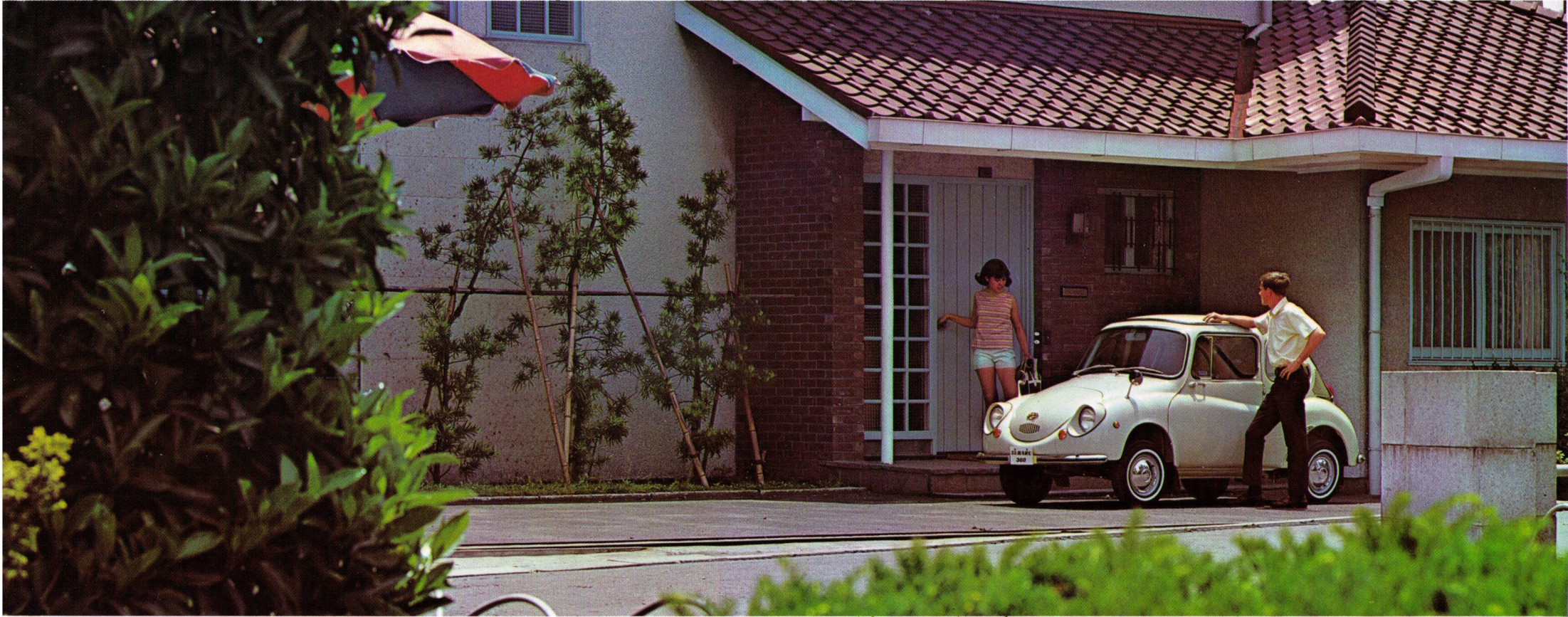

The driver's seat of the Subaru 360 is designed for wide visibility, easy driving and safety. The meters, gauges and indicators are grouped for maximum convenience and accurate, at-a-glance readings in the non-glare instrument panel directly in front of the driver. All knobs, switches and levers for headlights,

windshield wipers, combination flasher/dimmer, floor-mounted gear shift, hand brake, choke, heater and fuel are located within easy reach of the driver for maximum control efficiency.

The semi-separated front seats slide forwards or backwards in five stages to suit the physical requirements of the

driver or passenger for the most comfortable fatigue-free driving or riding comfort with plenty of leg room. And there's a large and convenient luggage shelf under the dashboard.

Features for safe driving include padded dashboard and horn button, safety belts, double interlocked anti-glare treated

windshield wipers which operate in a wider arc for maximum visibility in the rain, a sun visor that swings from the front window to the door window to fully protect the driver's eyes from blinding sunlight, tumbler type lighting switch to eliminate lighting mistakes, and a wide panoramic windshield.

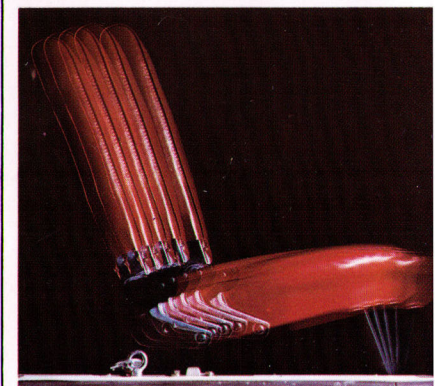
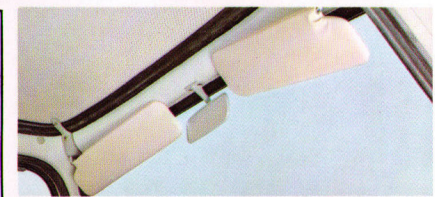
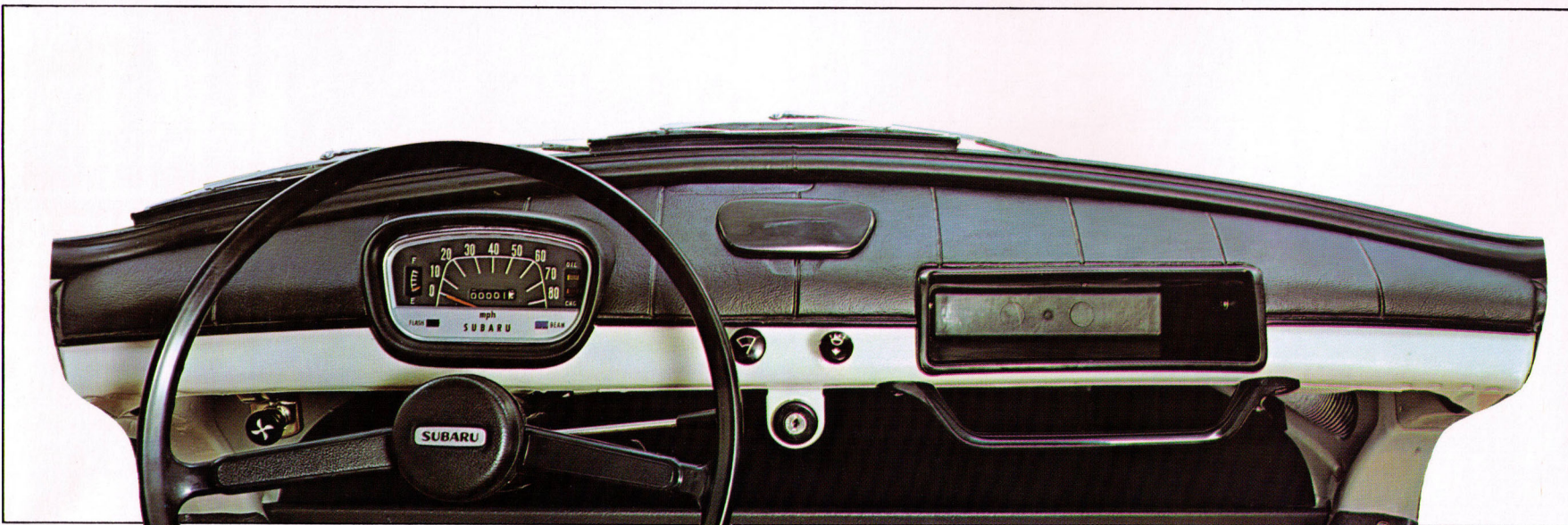
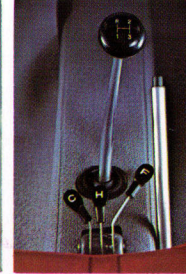
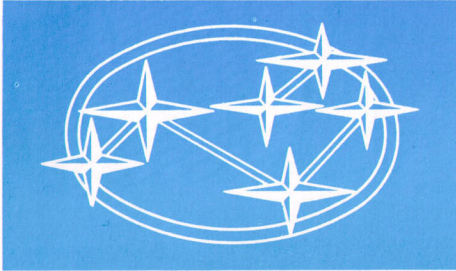

The pleasures of driving a Subaru 360

The luxurious two-toned upholstery, which matches the body color, beautifies the serene interior of the Subaru 360. This vehicle is designed to seat four adults in comfort with plenty of leg room for all. The wide doors and adjustable front seats make access into the back seat very easy. The front seats can also be reclined

all the way back to the rear seat level for exquisite relaxation.

There's no ventilation problem. The dual-type front windows and van-type rear windows provide comfortable ventilation. Children ride with added protection in the back seat of this two-door model. As for safety, there are the three-

point and two-point safety belts for the front and rear seats respectively.

Additional convenient features include the door pockets for slipping in maps, magazines, letters and other miscellaneous items, and the rear luggage shelf for groceries and other shopping items.

The Subaru 360 is truly a handy second

or third car for shopping, driving the children to school, or for teenagers in running errands.

Safety belts are attachable.

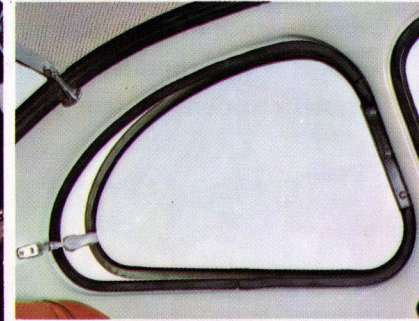

Luxurious and comfortable interior

2-stroke, 2-cylinder, air-cooled engine

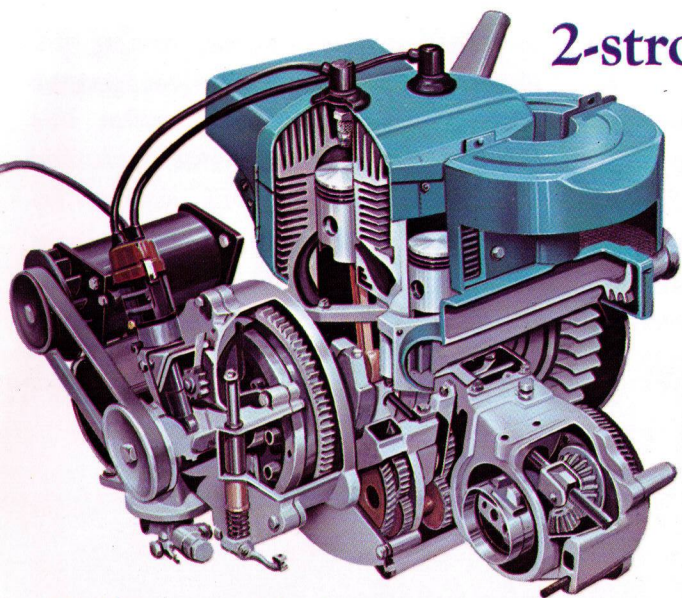

Safe, positive braking system

The front brakes on the Subaru 360 are of the powerful two-leading type and the rear brakes are of the stabilized leading-trailing type.

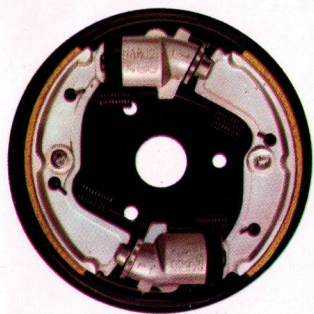

Front Brake

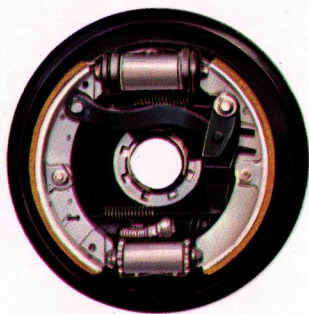

Rear Brake

The high performance engine mounted on the rear of the Subaru 360 is very dependable and durable. Very little can go wrong with it because of its simple mechanism and rationalized design.

The engine is air-cooled and works in any climate, hot or cold. You'll never have the experience of over-heating the engine because it incorporates Subaru's unique forced-air cooling system and there's no

water to boil. What's more, the fan is mounted directly on the crankshaft, making an interruption in the cooling system impossible. And in winter you won't have to worry about anti-freeze because there's no water to freeze. You can start the engine instantly in the coldest weather. And since you don't need water, there's no necessity for a radiator, water pump or water jacket. Thus, the engine is very light.

The 356 cc Subaru power unit develops 25 hp at 5,500 rpm and a maximum speed of 110 km/h (69.3 mph). It also boasts a fast acceleration of only 14.1 seconds for 200 meters. The rugged engine responds smoothly to both the requirements of heavy city traffic and high speeds on the highways.

"Subarumatic"... the secret of high performance

"Subarumatic" is an unprecedented lubrication system developed entirely by Subaru. Under this system gasoline and oil are supplied independently, and the engine has a completely separate lubrication system. This means greater durability in continuous high-speed running, longer service life for the engine, reduced oil consumption, longer service life for the spark plugs, decrease in exhaust fumes and less carbon in the cylinders.

Subarumatic Lubrication Diagram

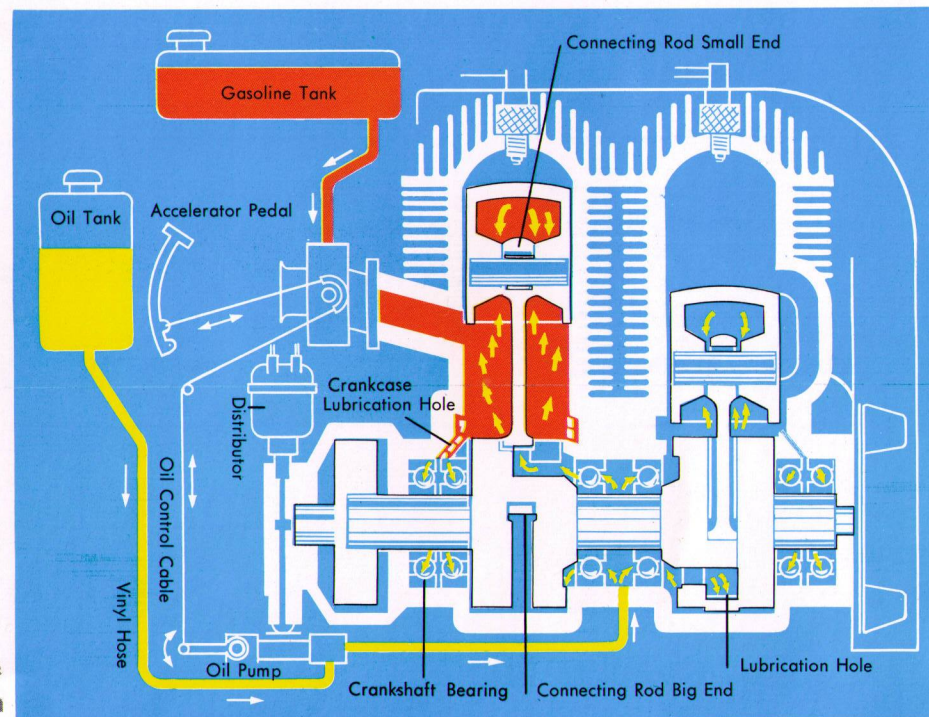

High maneuverability

This 118-inches long, 51-inches wide mini car has a surprisingly small minimum turning circle of only 26.2 feet. This, plus the light and smooth turning rack and pinion steering gear makes parking in tight places a breeze.

Floating-on-air comfort suspensions

The Subaru 360 is designed with independent suspensions on all four wheels to give you that floating-on-air riding sensation. The front suspensions are of the trailing arm type with torsion bar, center coil spring and hydraulic shock absorber. The rear suspensions are of the swing axle type with torsion bar and hydraulic shock absorber.

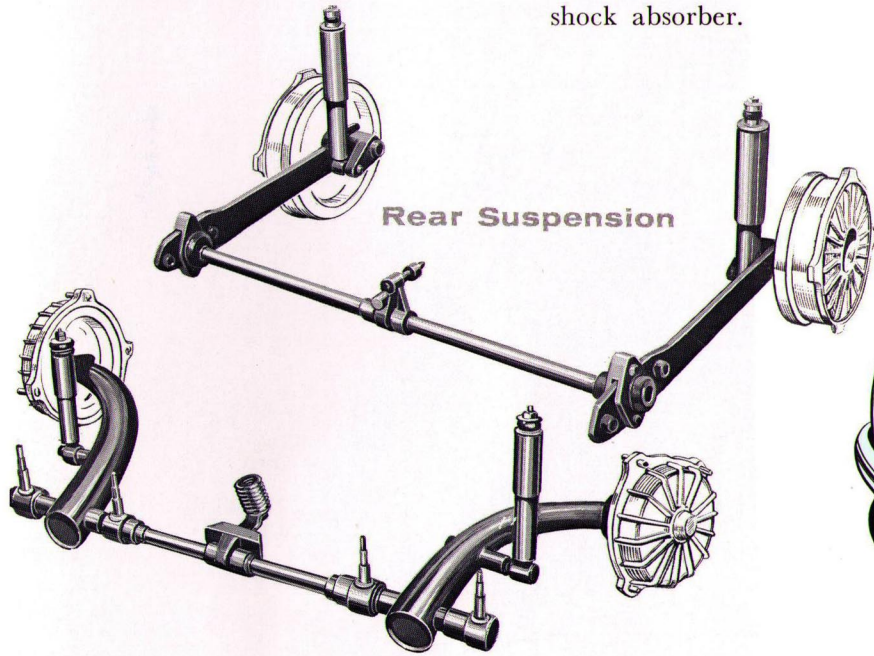

Rear Suspension

Front Suspension

Light and sturdy monocoque body

The monocoque body of the Subaru 360 was designed on the old principle that, like the shell of an egg, a single unit shell construction is stronger if it is round. Thus, we came up with the now famous Subaru 360 styling and succeeded in eliminating the need for a heavy frame-work which, in turn, made possible the

more spacious interior. Weight is evenly distributed over the entire surface of this unique structure, a masterpiece in designing to withstand the severest degree of twisting and bending on the roughest roads. And the lightness of the vehicle gives superb performance and unbelievable economy.

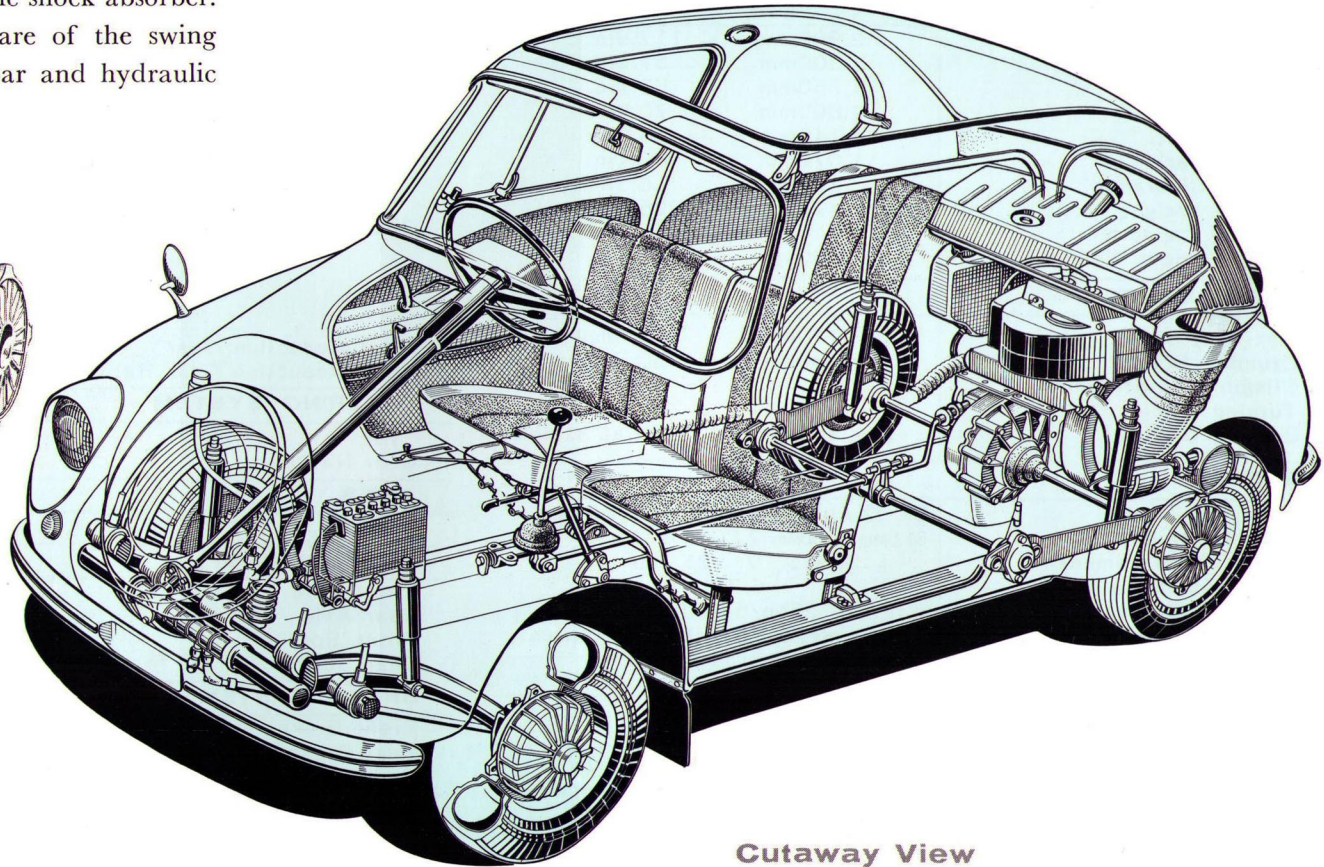

Cutaway View

\$1,297. | **UP TO 66 miles per gallon**

Suggested retail price P.O.E
SUBARU 360 SPECIFICATIONS

DIMENSIONS & WEIGHTS

Overall Length	2,995mm	117.9in.
Overall Width	1,300mm	51.2in.
Overall Height	1,350mm	53.1in.
Wheelbase	1,800mm	70.9in.
Tread (Front)	1,140mm	44.9in.
Tread (Rear)	1,070mm	42.1in.
Ground Clearance	160mm	6.3in.
Vehicle Weight	420kg	925.0lb.
Seating Capacity	4 adults	
Total Vehicle Weight	640kg	1,410lb.

PERFORMANCE

Maximum Speed	110km/h	70.0mph
Cruising Speed	80km/h	50.0mph
Climbing Ability (Sin θ)	0.337	
Turning Circle	8.0m	26.2 ft.
Braking Distance	12m at 50km/h	39.4ft. at 31mph

ENGINE

Model and Type	EK-32 Air-cooled, 2stroke, 2cyl Engine
Bore x Stroke	61.5mm x 60mm 2.42in. x 2.36in.
Piston Displacement	356cc / 21.7cu. in.
Compression Ratio	6.7:1
Maximum Output	25hp/5,500rpm
Maximum Torque	3.5kg-m (25.3lb.-ft.) / 4,500rpm

ELECTRICAL EQUIPMENT

Battery	12V - 26AH
Generator	12V - 200W
Starter	12V - 600W

CLUTCH

Type	Dry Single Plate
------	------------------

FUEL AND OIL TANK CAPACITIES

Fuel Tank	25.0ℓ (6.60US gal. 5.50 Imp. gal.)
Oil Tank	2.5ℓ (2.60US qt. 2.20 Imp. qt.)

TRANSMISSION

No. of Speeds	4-speed forward, 1-reverse
Transmission Type	Synchromeshed on 2nd, 3rd and Top speed, selective sliding on reverse

Gear Ratios	1st; 3.130 2nd; 1.601 3rd; 1.000 Over Top; 0.806 Rev; 4.248
Final Reduction Gear	Helical Gear 3.667
Final Reduction Gear Ratio	

STEERING SYSTEM

Type	Rack and Pinion
Gear Ratio	20.6:1

TIRES

Size	4.80 - 10 - 2
------	---------------

SUSPENSIONS

Front Axle	Trailing Arm Type Independent Suspension
Rear Axle	Swing Axle Type Independent Suspension
Front Spring	Torsion Bar and Coil Spring
Rear Spring	Torsion Bar

BRAKE SYSTEM

Front Brake	Hydraulic two Leading Type
Rear Brake	Hydraulic leading Trailing Type
Parking Brake	Mechanical on rear wheels

BODY

Type	Monocoque
------	-----------

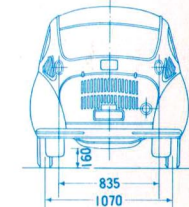
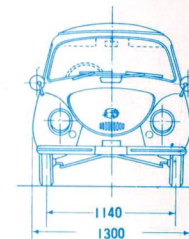
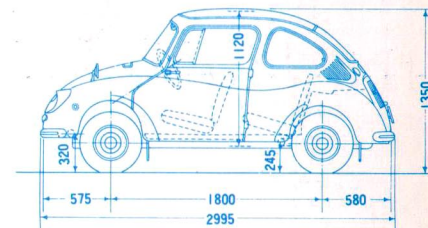
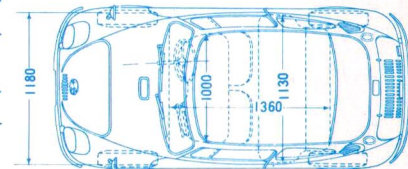

FUJI HEAVY INDUSTRIES LTD.

SUBARU
OF AMERICA, INC